



# ELECTRIC CHAIN SAW

18-INCH | 14-AMP

## OPERATOR'S MANUAL

A Division of Snow Joe®, LLC

Model SWJ701E

Form No. SJ-SWJ701E-880E-MR4

## IMPORTANT! Safety Instructions

### All Operators Must Read These Instructions Before Use

Read all the instructions contained in this manual. Keep this manual in a safe place, so that the information is available at all times. If you give the equipment to another person, make sure to provide these operating instructions. Basic safety precautions should always be followed to reduce the risk of fire, electric shock and personal injury.

Notice the personal safety alert symbol  used in this manual to draw your attention to a **WARNING** given along with the particular operating instruction. This means that the operation requires special **ATTENTION, CAUTION** and **AWARENESS**.

### Intended use

This machine was designed and manufactured for felling, bucking, and delimiting trees or cutting wooden objects with dimensions suitable for the cutting bar's capabilities.

### Improper use

Any other use differing from the above mentioned applications poses a serious hazard to the user and may damage both the tool and your personal property. Examples of improper use include, but are not limited to:

- Trimming hedges;
- Carving;
- Sectioning pallets, crates and various packing materials;
- Sectioning furniture or other materials with nails, screws or other metal components;
- Butchering meat;
- Using the machine to lift, move or split objects;
- Using the machine while fastened to fixed supports.

Improper use of the machine will invalidate the warranty, relieve the manufacturer from all liabilities, and the user will consequently be liable for any and all damage or injury to himself/herself or others.

## General Safety

 **WARNING!** When using electric yard tools, basic safety precautions should always be followed to reduce the risk of fire, electric shock, and personal injury, including the following:

1. **Keep guards in place** – Protective guards should be checked periodically to ensure they are properly fitted and in correct working order.
2. **Remove adjusting keys and wrenches** – Check that adjusting wrenches are removed from the saw before turning it on.
3. **Keep work area clean and well-lit** – Clear work area of branches and limbs after each cutting session. Cluttered areas invite accidents.
4. **Avoid dangerous conditions** – Do not use this machine in rainy, stormy, damp or wet locations. Do not operate the unit in gaseous or explosive atmospheres. Motors in these units normally spark, and the sparks may ignite fumes.
5. **Do not use the chain saw in the rain.**
6. **Keep bystanders and children away** – All bystanders, including children and pets, should be kept a safe distance away from the work area.
7. **Do not force the tool** – It will do the job effectively and safely if it is used at the rate for which it was designed.
8. **Use the right tool** – Do not force the tool or any attachment on the tool to do a job for which they were not designed.
9. **Wear proper apparel** – Do not wear loose articles of clothing or jewelry since such items may get caught in moving parts. Use of heavy-duty rubber gloves, substantial non-skid footwear, and close-fitting clothing is recommended when working outdoors with power tools.
10. **Wear protective hair coverings to contain long hair.**
11. **Always wear safety glasses and ear defenders to provide eye and ear protection** – Everyday eyeglasses only have impact resistant lenses and do not provide the same protection as safety glasses.
12. **Wear face or dust masks** – If the cutting operation is dusty, the use of a face or dust mask specially designed to filter out microscopic particles is recommended.
13. **Do not overreach** – Keep proper footing and balance at all times.
14. **Maintain tools with care** – Keep tools sharp and clean for the best and safest performance. Follow instructions for lubricating and changing accessories.

15. **Disconnect tool** – Disconnect the chain saw from the power supply when not in use, before servicing, when transporting, or when changing the chain or other accessories.
16. **Reduce the risk of unintentional starting** – Make sure the switch is in the OFF position before plugging the tool into a power source.
17. **Use recommended accessories** – Consult the owner's manual for recommended accessories. The use of improper accessories may cause risk of injury.
18. **Check for damaged parts** – Before each use, repair or replace any guard or part that is damaged. In addition, check for alignment of moving parts, binding of moving parts, breakage of parts, and any other conditions that may affect the tool's operation.
19. **Never leave tool unattended while it is running** – Turn the power OFF by removing the power cord directly from its socket. Do not leave the saw until the cutting bar comes to a complete stop.
20. **Avoid unintentional starting** – Do not carry the chain saw with your finger on the switch.
21. **Do not grasp the exposed cutting blade or cutting edges when picking up or holding the saw** – Be sure to encase the cutting bar in its protective sheath when not in use.
22. **Stay alert** – Watch what you are doing. Use common sense. Do not operate the chain saw when you are tired.
23. **Store idle tool indoors** – When not in use, appliances should be stored indoors in a dry and high or locked-up place out of the reach of children.

**⚠️WARNING!** Some dust and debris created by the use of the tool could contain chemicals known to the State of California to cause cancer and birth defects or other reproductive harm. Some examples of these chemicals are:

- Chemicals in fertilizers
- Compounds in insecticides, herbicides, and pesticides
- Arsenic and chromium from chemically treated lumber

Your risk from exposure to these chemicals varies, and depends on how often you do this type of work. To reduce your exposure, work in a well-ventilated area and with approved safety equipment, such as dust masks that are specially designed to filter out microscopic particles.

## Chain Saw Use And Care

Save all warnings and instructions for future reference. The term "power tool" in the warnings refers to your electric chain saw.

**⚠️WARNING!** Turn off the power switch and disconnect the power source before adjusting, inspecting, servicing or cleaning the power tool, when changing accessories or when any other dangerous conditions present themselves. All maintenance tasks should be performed after the power tool's rotating parts have stopped completely. Such preventive safety measures reduce the risk of starting the power tool accidentally.

1. Do not force the power tool. Use the correct power tool for your application. The correct power tool will perform better with less likelihood of personal or mechanical damage if it is used at the rate for which it was designed.
2. Do not use the power tool if the switch does not turn it on and off. Any power tool that cannot be controlled with the switch is dangerous and must be repaired.
3. Disconnect the unit from the power source before making any adjustments, changing accessories, or storing the power tool. Such preventive safety measures reduce the risk of starting the power tool accidentally.
4. Store idle power tools indoors in a dry, locked place out of the reach of children. Do not allow anyone who is unfamiliar with the power tool or these instructions access to the machine. Power tools are dangerous in the hands of untrained users.
5. Maintain power tools with care to ensure safe operation and optimal performance. Keep handles dry, clean and free from oil and grease. Check for misalignment or obstruction of moving parts, breakage of parts and any other condition that may affect the power tool's operation. If damage is found, have the power tool repaired before use. Many accidents are caused by poorly maintained power tools.
6. Keep cutting tools sharp and clean. Properly maintained cutting tools with sharp cutting edges are less likely to become jammed and are easier to control.
7. Use the power tool and accessories in accordance with these instructions, and be sure to take into account the working conditions and the work to be performed. Using the power tool for operations other than those intended could result in a hazardous situation.
8. Moving parts present risks. Keep your face, hair, clothing, hands and feet away from all moving parts. All guards and safety attachments must be installed properly before using the power tool. Shut off and disconnect the battery before touching any parts other than the handles and the switch.

# Electrical safety

1. Ground fault circuit interrupter (GFCI) protection should be provided on the circuit(s) or outlet(s) to be used for this electric chain saw. Receptacles are available having built-in GFCI protection and may be used for this measure of safety.
2. Make sure that the mains voltage matches that listed on the unit's rating label. Using the improper voltage can damage the motor and injure the user.
3. To prevent electric shock, use only with an extension cord suitable for outdoor use, such as SW-A, SOW-A, STW-A, STOW-A, SJW-A, SJOW-A, SJTW-A, or SJTOW-A.

Before use, check that the extension cord is in good condition. When using an extension cord, make sure to use one heavy enough to carry the current your product will draw. For lengths less than 50 ft (15 m), a No. 14 AWG (or greater) extension cord should be used. An undersized cord will cause a drop in line voltage resulting in loss of power and overheating.

WARNING

**Electric shock may cause SEVERE INJURY or DEATH. Heed these warnings:**

- Do not allow any part of the electric chain saw to make contact with water while it is in operation. If the appliance becomes wet while turned off, wipe dry before starting.
- Use only a UL-, CSA-, or ETL-rated extension cord for outdoor, all-weather use.
- Do not use an extension cord over 100 ft (30 m).
- Do not touch the appliance or its plug with wet hands or while standing in water. Wearing rubber boots offers some protection.

**EXTENSION CORD CHART**

Extension Cord Length	Up to 50 ft (15 m)	+50 ft - 100 ft (+15 m - 30 m)
Wire Gauge (A.W.G.):	14	12

4. To reduce the risk of electric shock, this appliance has a polarized plug (i.e. one blade is wider than the other). Use this appliance only with a polarized UL-, CSA- or ETL-listed extension cord recommended for outdoor, all-weather use.

The appliance plug will fit into a polarized extension cord only one way. If the appliance plug does not fit fully into the extension cord, reverse the plug. If the plug still does not fit, obtain a correct polarized extension cord. A polarized extension cord will require the use of a polarized wall outlet. The extension cord plug will fit into the polarized wall outlet only one way. If the plug does not fit fully into the wall outlet, reverse the plug. If the plug still does not fit, contact a qualified electrician to install the proper wall outlet. Do not modify the appliance plug, extension cord receptacle or extension cord plug in any way.

5. To prevent the appliance cord from disconnecting from the extension cord during operation, use the on-board extension cord restraint hook and/or make a knot as shown in Table 1.

**Table 1. Method of Securing Extension Cord**

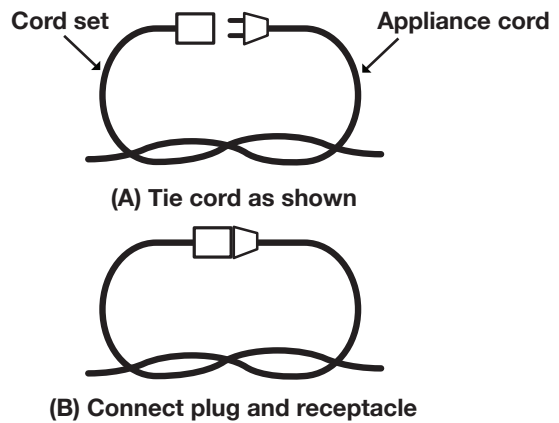

6. Do not abuse the cord. Never pull the chain saw by the cord or yank the cord to disconnect it from the receptacle. Keep the cord away from heat, oil and sharp edges.

## Double-Insulated Appliances

In a double-insulated appliance, two systems of insulation are provided instead of grounding. No grounding means are provided on a double-insulated appliance, nor should a means for grounding be added to the appliance. Servicing a double-insulated appliance requires extreme care and knowledge of the system, and should be performed only by qualified service personnel at an authorized Snow Joe® + Sun Joe® dealer. Replacement parts for a double-insulated appliance must be identical to the parts they replace. A double-insulated appliance is marked with the words "Double Insulation" or "Double Insulated." The symbol (square within a square) may also be marked on the appliance.

**DOUBLE-INSULATED: GROUNDING NOT REQUIRED. WHEN SERVICING, USE ONLY IDENTICAL REPLACEMENT PARTS.**

This electric chain saw is double-insulated, eliminating the need for a separate grounding system. Use only identical replacement parts. Read the instructions before servicing double-insulated appliances. Use this chain saw only as described in this manual.

## Service

- Have your power tool serviced by a qualified repair person at an authorized Snow Joe® + Sun Joe® dealer using only identical replacement parts or call the Snow Joe® + Sun Joe® customer service center at 1-866-SNOWJOE (1-866-766-9563). This will ensure that the safety of the power tool is maintained.

## Chain Saw Safety Warnings

- Keep all parts of the body away from the saw chain when the chain saw is operating. Before you start the chain saw, make sure the saw chain is not in contact with anything. A moment of inattention while operating the chain saw may cause entanglement of your clothing or body with the saw chain.
- Always hold the chain saw with your right hand on the rear handle and your left hand on the front handle. Holding the chain saw with a reversed hand configuration increases the risk of personal injury and should never be done.
- Wear safety glasses and hearing protection. If you are using the chain saw every day under normal conditions, you can be exposed to a noise level of 85 dB (A) or higher. Further protective equipment for head, hands, legs and feet is recommended. Adequate protective clothing will reduce personal injury by flying debris or accidental contact with the saw chain.
- Do not operate the chain saw in a tree. Operation of a chain saw while up in a tree may result in personal injury.
- Always keep proper footing and operate the chain saw only when standing on a fixed, secure and level surface. Slippery or unstable surfaces such as ladders may cause a loss of balance or control of the chain saw.
- When cutting a limb that is under tension, be cautious of spring back. When the tension in the wood fibers is released, the spring-loaded limb may strike the operator and/or throw the chain saw out of control.
- Use extreme caution when cutting brush and saplings. The slender material may catch the saw chain and be whipped toward you or pull you off balance.
- Carry the chain saw by the front handle with the chain saw switched off and away from your body. When transporting or storing the chain saw, always fit the cutting bar sheath. Proper handling of the chain saw will reduce the likelihood of accidental contact with the moving saw chain.
- Follow instructions for lubricating, chain tensioning and changing accessories. An improperly tensioned or poorly lubricated chain may either break or increase the chance for kickback.

- Keep handles dry, clean and free from oil and grease. Greasy, oily handles are slippery and can cause loss of control.
- Cut wood only. Do not use the chain saw for any other purpose. For example, do not use the chain saw to cut plastic, masonry or non-wood building materials. Using the chain saw in these incorrect ways could result in serious damage to you and your tool.

## Causes and Prevention of Kickback

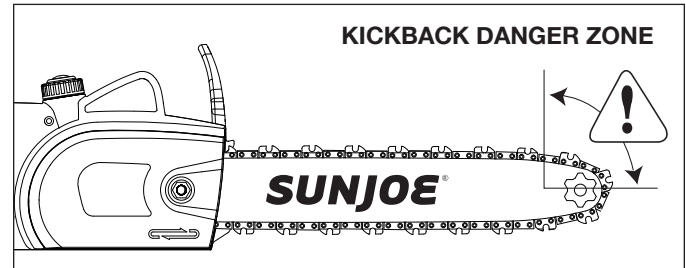

Kickback may occur when the nose or tip of the guide bar touches an object, or when the wood closes in and pinches the saw chain in the cut. Tip contact in some cases may cause a sudden reverse reaction, kicking the guide bar up and back towards the operator.

Pinching the saw chain along the top of the guide bar may push the guide bar rapidly back towards the operator.

Either of these reactions may cause you to lose control of the saw which could result in serious personal injury. Do not rely exclusively upon the safety devices built into your saw.

As a chain saw user, you should take several steps to keep your cutting jobs free from accident or injury.

Kickback is the result of tool misuse and/or incorrect operating procedures or conditions and can be avoided by taking proper precautions as detailed below:

- Maintain a firm grip (right hand on the rear handle and left hand on the front handle with thumbs and fingers encircling the respective handles) and position your body and arms to allow you to resist kickback forces. Kickback forces can be controlled by the operator if proper precautions are taken. Do not let go of the chain saw.
- Do not overreach and do not cut above shoulder height. This helps prevent unintended tip contact and enables better control of the chain saw in unexpected situations.
- Only use replacement bars and chains specified by the manufacturer. Incorrect replacement bars and chains may cause chain breakage and/or kickback.
- Follow the manufacturer's sharpening and maintenance instructions for the saw chain. Decreasing the depth gauge height can lead to increased kickback.
- Always observe the safety regulations and follow the correct sawing techniques.

- Ensure safe carrying of the chain saw. Whenever the machine is to be handled or transported, you must:
  - Switch off the motor, wait for the chain to stop and enable the chain brake;
  - Mount the guide bar cover;
  - Hold the machine using the hand grips and position the bar in the opposite direction to that used during operation.

When using a vehicle to transport the machine, fasten it firmly and position it so that it is not a danger to any passengers.

- Before felling or delimiting for the first time, make sure:
  - You have been specifically trained to use this type of equipment;
  - You have carefully read the safety regulations and user instructions contained in this manual;
  - You practice first on logs on the ground or attached to trestles/saw horses, in order to get familiar with the machine and the proper cutting techniques.

## Safety Chain Brake

In the event that kickback occurs, use your left hand to apply the chain brake by moving the safety chain brake lever to position '0' (Fig. A). This will immediately stop the chain.

The operation of the chain brake must be checked prior to each use.

**⚠WARNING!** To reset the chain brake, disconnect the tool from the mains power and snap the chain brake backwards (towards the operator) into position '1' (Fig. A). Recheck the chain tension before restarting.

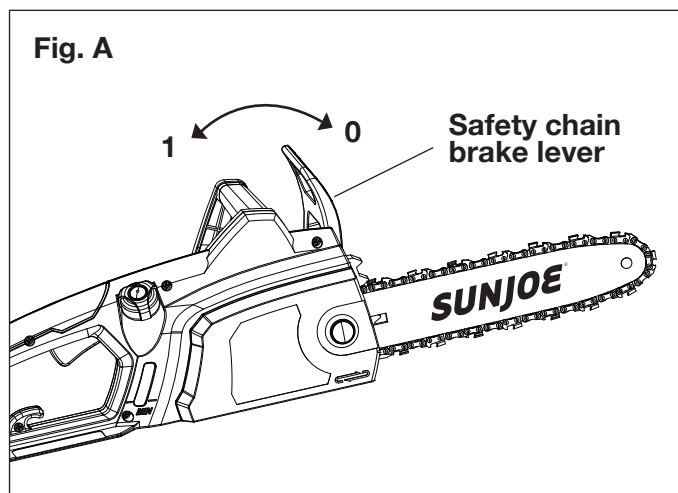

















## Protection from environmental influences

1. Wear suitable work clothes. Wear safety goggles.
2. Protect your power tool from moisture and rain. Moisture and rain can cause dangerous electrical and motor damage.
3. Do not use the power tool near vapors and flammable liquids.
4. Use the power tool only in dry conditions and at an ambient temperature of 50-104°F (10-40°C).
5. Store your power tool only in dry locations with an ambient temperature of 50-104°F (10-40°C). Protect the power tool from humidity and direct sunlight.

# Safety Symbols

The following table depicts and describes safety symbols that may appear on this product. Read, understand and follow all instructions on the machine before attempting to assemble and operate.

Symbols	Descriptions	Symbols	Descriptions
	<b>READ THE OPERATOR'S MANUAL(S)</b> – Read, understand and follow all instructions in the user manual(s) before attempting to assemble and operate.		Keep bystanders and children a safe distance away.
	<b>SAFETY ALERT</b> – Indicates a precaution, a warning or a danger.		<b>WEAR EYE AND HEARING PROTECTION</b> – For protection against injury, wear ear defenders and safety goggles.
	<b>WARNING!</b> Do not expose the unit to rain or wet conditions.		Wear protective gloves and non-slip footwear when using the machine and handling debris.
 	<b>DANGER! ROTATING BLADES</b> – Keep hands and feet away from openings while the saw is running.		Correct direction of cutting teeth.
 	<b>CAUTION!</b> Avoid contacting the guide bar tip with any object. Tip contact may cause the guide bar to move suddenly upward and backwards, which may cause serious injury to the user.	 	<b>WARNING!</b> Two hands are always to be used when operating the chain saw.
	<b>SWITCH OFF!</b> Remove plug from outlet before cleaning or conducting maintenance checks.		<b>SWITCH OFF!</b> Remove plug from outlet immediately if the cord is damaged or cut.
	The rotating part will continuously run for several seconds after you turn off the machine.		Double Insulation.

# Know Your Electric Chain Saw

Read the owner's manual and safety rules carefully before operating your electric chain saw. Compare the illustration below to the actual unit in order to familiarize yourself with the location of the various controls and adjustments. Save this manual for future reference.

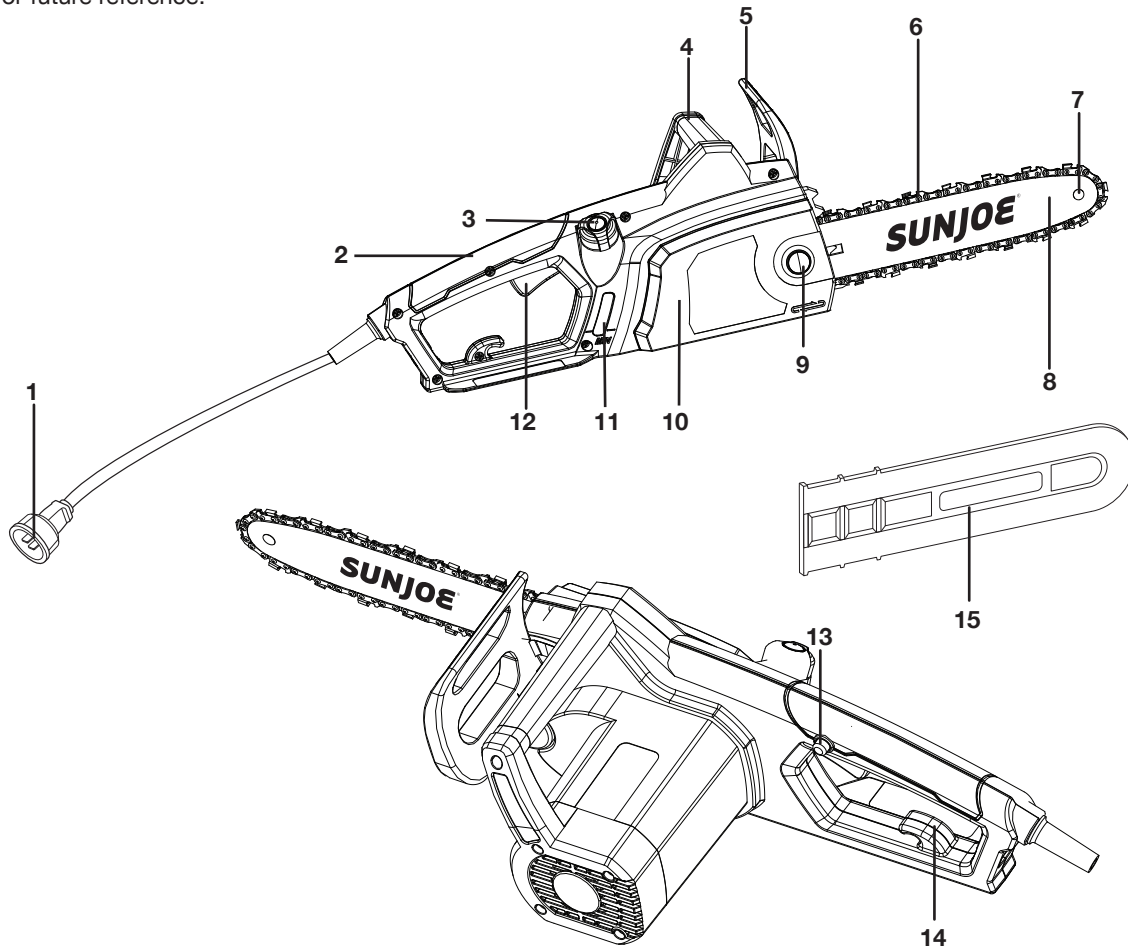

- |                             |                                      |
|-----------------------------|--------------------------------------|
| 1. Appliance cord           | 9. End cover nut with decorative cap |
| 2. Rear handle              | 10. Sprocket/chain end cover         |
| 3. Oil tank cap             | 11. Oil level indicator window       |
| 4. Front handle             | 12. Trigger switch                   |
| 5. Safety chain brake lever | 13. Safety lock button               |
| 6. 18 in. cutting chain     | 14. Extension cord restraint hook    |
| 7. Guide bar nose sprocket  | 15. Cutting bar sheath               |
| 8. 18 in. guide bar         |                                      |

## Technical Data

Rated Voltage	120 V ~ 60 Hz	Cutting Thickness	Max: 17.5 in. (44.5 cm) Recommended: 16.5 in. (42 cm)
Power	14 A	Oil Tank Capacity	3 fl oz (90 ml)
No Load Speed	8000 rpm	Chain Speed	47.6 ft/s (14.5 m/s)
Bar/Chain Length	18 in. (45.7 cm)	Weight	9.7 lbs (4.4 kg)

# Unpacking

## Carton Contents

- Electric chain saw
- 18 in. (45.7 cm) cutting chain
- 18 in. (45.7 cm) guide bar
- Dual-tipped hex key wrench/blade screwdriver
- Cutting bar sheath
- Manuals with registration card

1. Carefully remove the chain saw and check to see that all of the above items are supplied.
2. Inspect the product carefully to make sure no breakage or damage occurred during shipping. If you find damaged or missing parts, DO NOT return the unit to the store. Please call the Snow Joe® + Sun Joe® customer service center at 1-866-SNOWJOE (1-866-766-9563).

**NOTE:** Do not discard the shipping carton and packaging material until you are ready to use your new electric chain saw. The packaging is made of recyclable materials. Properly dispose of these materials in accordance with local regulations.

**IMPORTANT!** The equipment and packaging material are not toys. Do not let children play with plastic bags, foils or small parts. These items can be swallowed and pose a suffocation risk!

## Assembly

**⚠ WARNING!** Always wear heavy-duty gloves when handling the bar and chain. Mount the bar and chain very carefully so as not to impair the safety and efficiency of the machine. If in doubt, contact an authorized Snow Joe® + Sun Joe® dealer or call the Snow Joe® + Sun Joe® customer service center at 1-866-SNOWJOE (1-866-766-9563).

**⚠ WARNING!** Unpacking and assembly should be completed on a flat and stable surface, with adequate space for moving the machine and its packaging.

**⚠ DANGER!** Never start the motor before installing the guide bar, chain, and end cover. Without all these parts in place, the clutch/sprocket can fly off or explode, exposing the user to potentially serious injuries.

**⚠ WARNING!** To avoid serious personal injury, read and understand all safety instructions provided.

**⚠ WARNING!** Before performing any maintenance, make sure the tool is unplugged from the power supply. Failure to heed this warning could result in serious personal injury.

## Installing the Guide Bar and Chain

Tools and supplies required:

- Dual-tipped hex key wrench/blade screwdriver (supplied)
- Heavy-duty work gloves

**NOTE:** When replacing the guide bar and chain, use only identical replacement parts. Make sure the chain saw is disconnected from the power supply before proceeding with installation.

1. Using the supplied flat-tip blade screwdriver, remove the end cover nut cap from the chain/sprocket end cover to expose the end cover nut (Fig. 1).
2. Using the supplied hex key wrench, unscrew the end cover nut and remove the chain/sprocket end cover (Fig. 1).

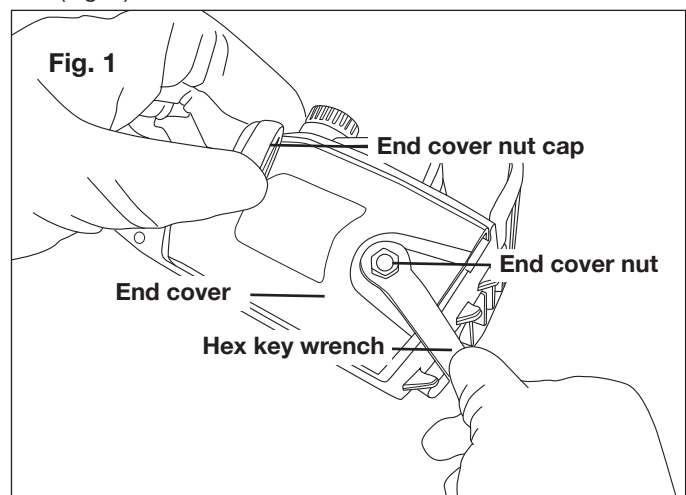

3. Lay out the new saw chain in a loop and straighten any kinks. **THE SHARP SIDE OF THE TEETH MUST FACE AWAY FROM YOU AND IN THE DIRECTION OF THE CHAIN ROTATION INDICATED ON THE GUIDE BAR.** If the teeth face backwards, turn the loop over (Fig. 2).

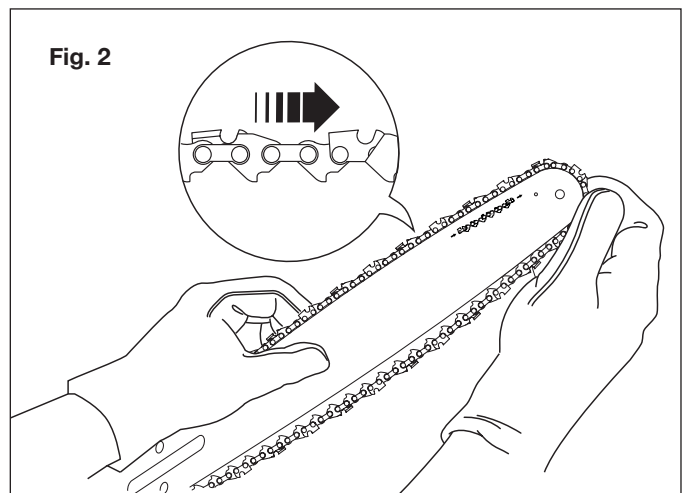



- Starting at the tip, mount the chain drive links into the bar groove, leaving a loop at the back of the bar. The chain will loosely fit until it is placed on the sprocket (Fig. 3).

**NOTE:** Make certain of the direction of the chain. If the chain is mounted backwards, the saw will vibrate abnormally and will not cut.

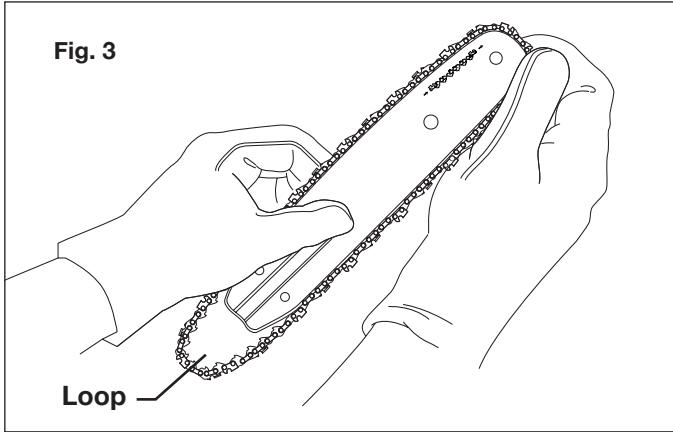

- Hold the chain in position on the bar and place the loop around the sprocket. Fit the bar flush against the mounting surface so that the bar studs are in the long slot of the bar and the adjusting pin is in the chain tension pin hole (Fig. 4).

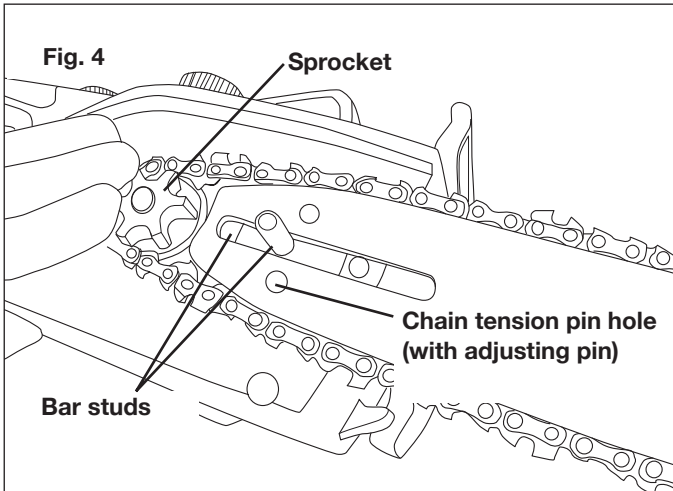

**NOTE:** If the adjusting pin will not reach the chain tension pin hole, turn the chain tensioning screw counter-clockwise until the pin hole aligns with the adjusting pin (Fig. 5).

- While keeping the bar and chain flush against the mounting surface, adjust the chain tension as needed by adjusting the chain tensioner screw with the supplied flat-tip blade screwdriver. Turn the chain tensioner screw clockwise to tightening the chain, or counter-clockwise to loosen the chain (Fig. 5).

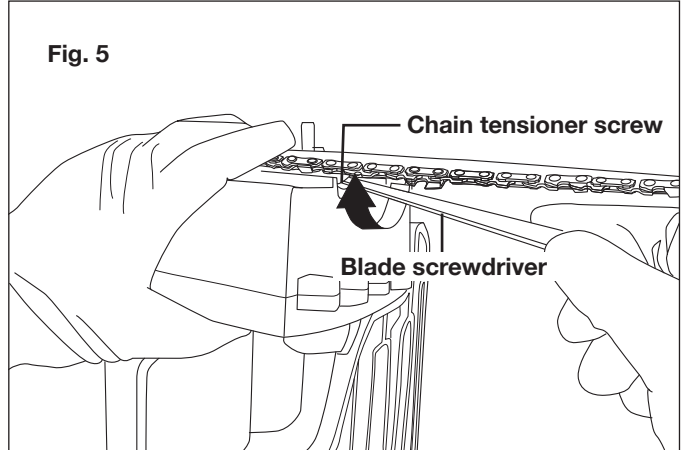

- Replace the chain/sprocket end cover by inserting the rear tab first into the rear tab slot and position the cover over the bar end. Tighten the end cover nut by hand; leave the bar loose enough to move slightly for tension adjustment (Fig. 6).

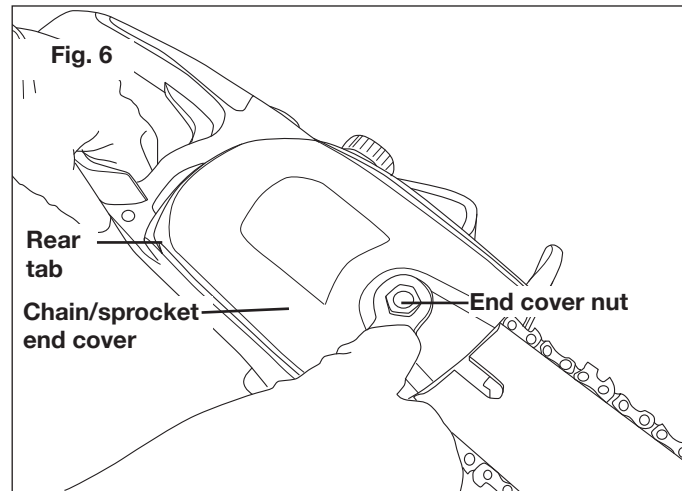

- Remove all slack from the chain by turning the chain tensioner screw clockwise until the chain seats snugly against the bar with the drive links flush inside the bar groove (Fig. 7).

**NOTE:** The chain is correctly tensioned when there is no sag on the underside of the guide bar; the chain is snug, but can be rotated by hand without binding. For more information on chain tensioning, see the maintenance section beginning on pg. 16.

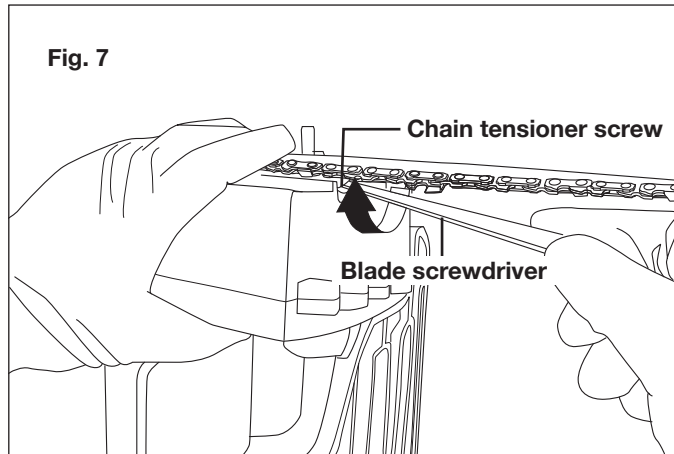

- Tighten the end cover nut completely using the hex key wrench (Fig. 6), then replace the end cover nut cap to secure the chain/sprocket end cover.

**NOTE:** If the chain is too tight, it will not rotate. Loosen the end cover nut slightly and turn the chain tensioner 1/4 turn counterclockwise. Lift the tip of the guide bar up and retighten the end cover nut. Ensure that the chain can be rotated by hand without binding.

**NOTE:** A new chain tends to stretch; check the chain tension frequently, and adjust tension as required.

## Replacing the Bar and Chain

- Disconnect the chain saw from the power supply.
- Using the dual-tipped hex key wrench/blade screwdriver, remove the end cover nut cap and then unscrew the end cover nut to remove the chain/sprocket end (Fig. 1).

- Remove the cutting bar and chain from the mounting surface (Fig. 8).

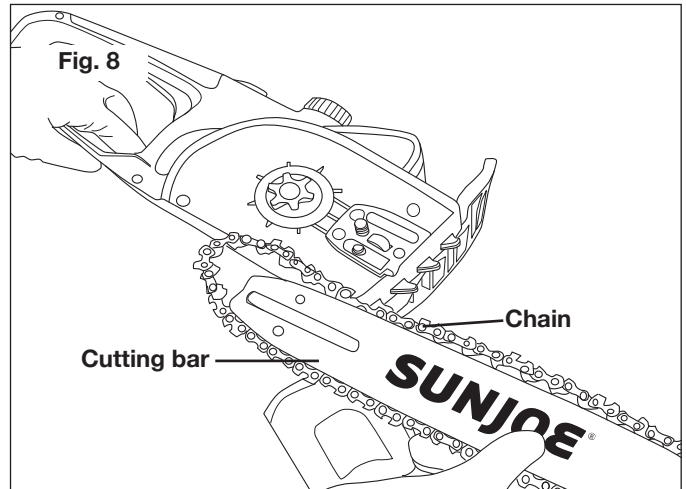

- Remove the old chain from the bar.
- To lay out and install the new saw chain properly, follow steps 3 to 9 from the section "Installing the Guide Bar and Chain" on page 8.

## Preparing To Work

### Checking the Machine

**⚠ WARNING!** Before performing any checks, adjustments, repairs or maintenance on the machine, make sure the unit is not connected to the power supply.

Before starting work, please:

- Check that all the screws on the machine and the guide bar are tightly fastened;
- Check that the chain is correctly tensioned, properly sharpened and there are no signs of any damage;
- Check that hand grips and protection devices are clean and dry, correctly mounted and securely fastened to the machine;
- Check that the chain brake is working efficiently;
- Check that the trigger switch and the safety button move freely without excessive force and return automatically and rapidly back to their neutral positions;
- Check that the trigger switch remains locked until the safety button is pressed;
- Make sure the cooling air vents are not clogged with sawdust or debris;
- Check that the chain's oil level is not below the "MIN" level mark; if necessary, top up the oil to 1 cm from the rim of the filler.

**NOTE:** You must fill the chain oil tank with bar and chain oil before using your chain saw.

## Adjusting the Chain Tension

**⚠️WARNING!** Before performing any checks, adjustments, repairs or maintenance on the machine, make sure the tool is unplugged from the power supply.

**⚠️CAUTION!** The chain will continue to run for several seconds after turning off the tool.

1. Loosen the end cover nut until it is hand-tight. Use the flat-tip blade screwdriver to turn the chain tensioner screw clockwise to tension the chain. A cold chain will be correctly tensioned when there is no slack on the underside of the guide bar; the chain is snug, but it can be turned by hand without binding (Fig. 9).

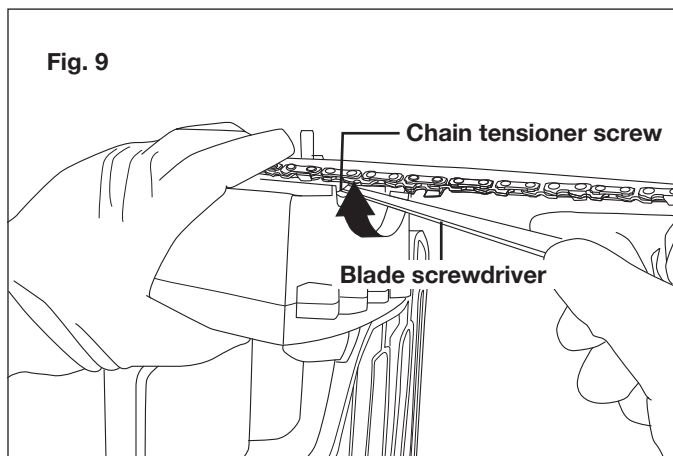

2. The tension is correct when the drive links on the chain do not slip out of the chain guide on the bar when the chain is pulled up from the middle of the bar (Fig. 10).

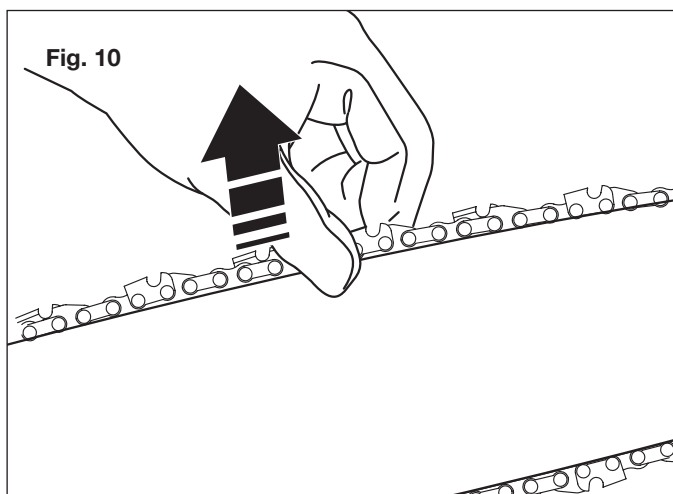

## Chain Lubricant

**⚠️CAUTION!** Failure to lubricate the chain will cause damage to the chain and bar. Use a good quality bar and chain oil or, if not available, unused SAE 30 weight motor oil may be substituted. One minute of use will consume approximately 0.2 fl oz. (6 ml) of oil.

**NOTE:** It's normal for oil to seep from the saw when not in use. To prevent seepage, empty the oil tank after each use. When storing the unit for a long period of time (3 month or longer), be sure the chain is lightly lubricated. This will prevent rust on chain and bar sprocket.

**⚠️WARNING!** Do not use the chain saw with any type of accessory or attachment. Such usage might be hazardous.

## Operation

### Starting the Machine

Before starting the chain saw, remove the oil tank cap and add bar & chain oil to the top of the oil level window (Fig. 11). One minute of use will consume approximately 0.2 fl oz (6 ml) of oil. Refill when the oil level drops to 1/4 of a tank.

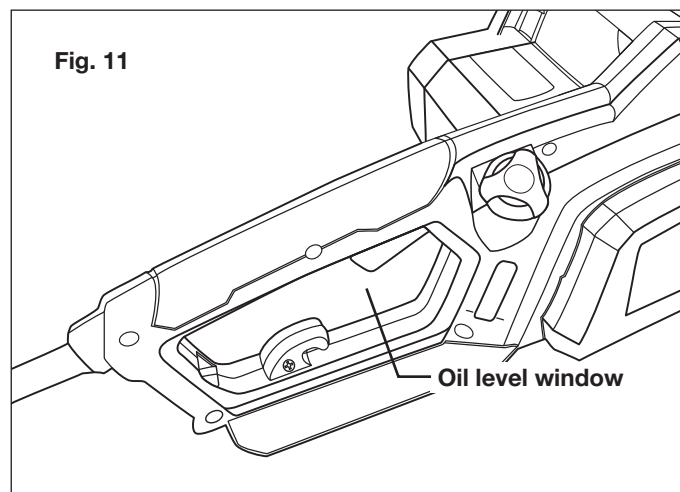

**NOTE:** Your electric chain saw is equipped with an automatic oil pump for bar and chain oiling. You must add bar and chain oil or your chain saw will malfunction.

1. Connect the electric chain saw to a working 120 V outlet using a heavy-duty outdoor extension power cord.

2. Make a loop in the power cord and push it up through the hole in the handle and around the cord restraint hook (Fig. 12), then connect the extension cord to the appliance cord.

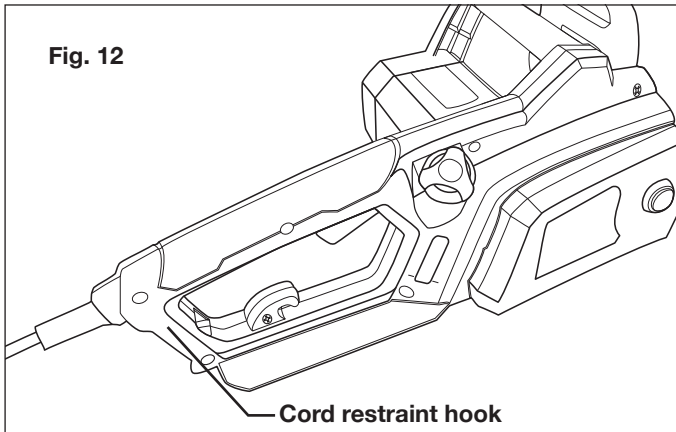

3. Make sure the guide bar is not touching the ground or any other object.
4. Hold the chain saw firmly with both hands.
5. To turn the tool ON, push and hold the safety lock button with your thumb and then squeeze the trigger with your fingers. Once the tool is running, you can release the safety lock button (Fig. 13).

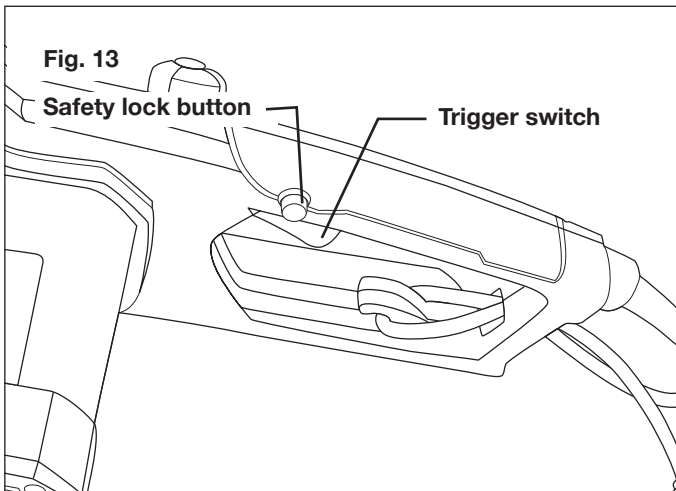

6. To turn the tool OFF, release the trigger switch (Fig. 13).

**NOTE:** Do not press the trigger switch until you are ready to make a cut.

## Operating Tips

**⚠ WARNING!** For your safety and that of others:

1. Do not use the machine without reading the instructions carefully. Become acquainted with the controls and the proper use of the machine. Learn how to stop the machine quickly.

2. Keep in mind that the operator or user is responsible for accidents or hazards occurring to other people or their property.

3. Always wear suitable clothing when using the machine. Wear anti-vibration gloves and other personal protective equipment.

**NOTE:** All the above-mentioned precautions do not, however, guarantee the prevention of certain risks – i.e. Raynaud's phenomenon or carpal tunnel syndrome. For operators who use this machine for prolonged periods, it is therefore recommended to have periodic checkups on their hands and fingers. If any of the above mentioned symptoms should appear, please contact a physician immediately.

4. Work only in daylight or good artificial light.
5. Take utmost care when working near metal fences.
6. Take care not to hit the bar hard against foreign objects or flying debris caused by the movement of the chain.
7. Do not operate the chain saw in a tree, on a ladder, or on a scaffold. This is extremely dangerous.
8. Use extreme caution when cutting small brush, saplings or limbs under tension, because slender and tense material may catch the saw and be whipped towards you, pull you off balance or spring back.
9. Do not cut vines and/or small underbrush.
10. Before you start the unit, make sure the chain saw is not contacting any object.

**⚠ CAUTION!** The chain coasts after saw is turned off. Do not use under wet condition.

**IMPORTANT!** Always remember that an incorrectly used chain saw may harm or disturb others and have a serious impact on the environment.

To respect people and the environment:

- Avoid using the machine in environments or at times of the day when it may disturb others.
- Scrupulously comply with local regulations and provisions for the disposal of waste materials after sawing.
- Scrupulously comply with local regulations and provisions for the disposal of oils, damaged parts or any elements which have a strong impact on the environment.
- A certain amount of chain lubricating oil is released into the environment when the machine is running, so only use biodegradable oils made specifically for this use.
- To avoid the risk of fire, do not leave the machine with the engine hot on leaves or dry grass.

**⚠ WARNING!** It takes specific training to use the machine for felling and delimiting.

**⚠️WARNING!** Prolonged exposure to vibrations can cause injuries and neurovascular disorders (also called “Raynaud’s syndrome” or “white hand”), especially to people suffering from circulation disorders. The symptoms can affect the hands, wrists and fingers and manifest with loss of sensitivity, numbness, itching, pain and discoloring of or visible changes to the skin. These effects can be worsened by low ambient temperatures and/or by gripping the hand grips too tightly. If the symptoms occur, the length of time the machine is used must be reduced and a doctor consulted.

## Checks During Work

- Checking the chain tension

The chain tends to stretch gradually as you work, so you need to check its tension frequently.

**IMPORTANT!** During the first period of use (or after replacing the chain), the chain tension must be checked more frequently due to settling of the chain.

**⚠️WARNING!** Never work with the chain loose, as it can be hazardous if the chain slips out of its guides.

To adjust the chain tension, follow the instructions in “Adjusting the Chain Tension” on page 11.

- Checking the oil delivery

**IMPORTANT!** Never use the machine without lubrication! You can check the oil level in the tank through the transparent gauge. Make sure you fill up the oil tank every time you use the machine. For best results, use only a good quality bar and chain oil designed specifically for use with chain saws.

**⚠️WARNING!** Make sure the bar and the chain are in place when you check the oil delivery.

Start the motor and check if the chain oil is delivered as shown below (Fig. 14).

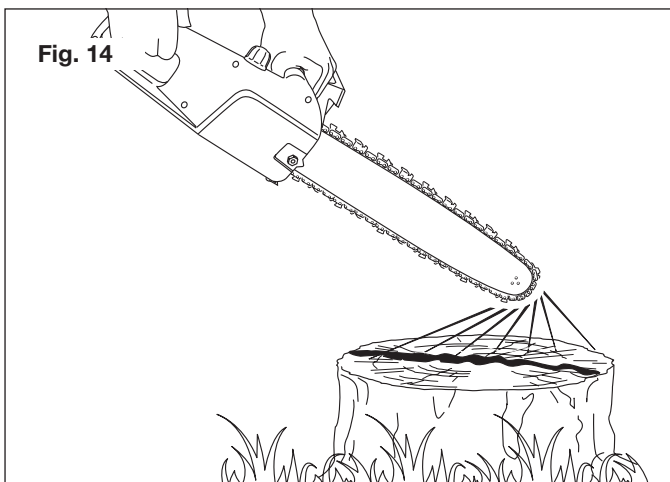

## Proper Cutting Stance

1. Weight should be balanced with both feet on solid ground.
2. Keep your left arm and elbow locked in a "straight arm" position to withstand any kickback force (Fig. 15).

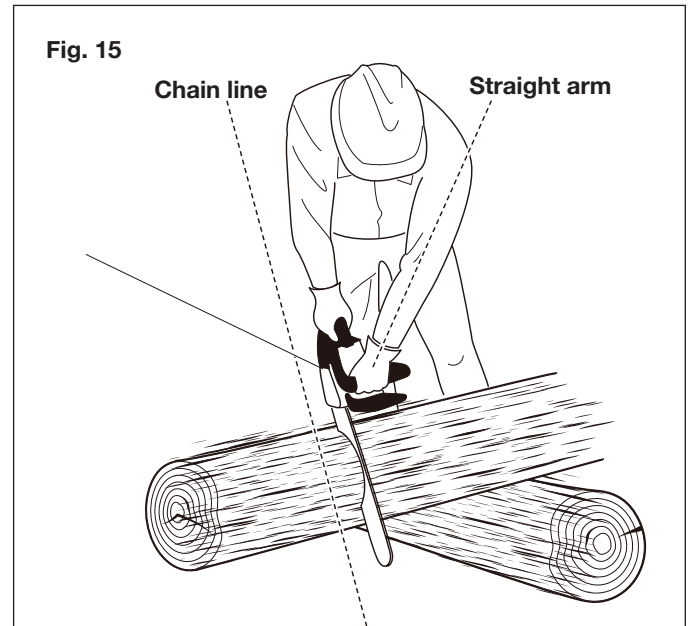

3. Your body will always be on the left of the chain line.

## Basic Cutting Procedures

1. Small trees up to 6 – 7 inches in diameters are usually cut in a single cut. Notch cuts determine the direction the tree will fall.

**⚠️WARNING!** If the tree starts to fall in a wrong direction, or if the saw got caught or hung up during the fall, leave the saw and save yourself.

**⚠️WARNING!** Periodically glance at the top of the tree during the back-cut to ensure the tree is going to fall in the desired direction.

2. Practice cutting a few small logs using the following techniques to get the feel of using the saw before you begin a major sawing operation.
3. Take the proper stance in front of the wood with the saw off.
4. Squeeze the trigger and let the chain accelerate to full speed before entering the cut.
5. Hold the saw with both hands firmly. Always keep your left hand on the front handle and your right hand on the rear handle so that your body is to the left of the chain line.
6. Keep the unit running the entire time you are cutting, maintaining a steady speed.

7. Allow the chain to cut for you; exert only light downward pressure. If you force the cut, damage to the bar, chain or unit can result.
8. Do not put the pressure on the saw at the end of the cut.
9. Always cut with both feet on solid ground to prevent being pulled off balance.
10. Do not cut above chest height, as a saw held higher is difficult to control against kickback force.

## Cutting Techniques

Before felling or delimiting for the first time, practice sawing logs on the ground or on trestles, so that you can get familiar with the machine and the most suitable sawing techniques.

When felling a tree, keep everyone a safe distance from the cutting area. During felling operation, the safest distance should be at least twice the height of the largest trees in the felling area. If the tree makes any contact with utility line, the utility company should be notified immediately.

**⚠️ WARNING!** Always hold the machine with both hands when sawing.

**⚠️ WARNING!** Stop the motor immediately if the chain stops during sawing. Beware of kickback, which can occur if the bar contacts an obstacle.

### • Felling a tree

- i) When bucking and felling are performed by two or more people at the same time, the felling operation should be separated from the bucking operation by a distance of at least twice the height of the tree being felled. Trees should not be felled in a manner that would endanger any person, strike any utility line or cause any property damage. If the tree does make contact with any utility line, the company should be notified immediately.

**⚠️ WARNING!** Check the tree for damaged or dead branches that could hit you during the felling.

- ii) The chain saw operator should stay on the uphill side of the terrain, as the tree is likely to roll or slide downhill after it is felled.
- iii) An escape path should be planned and cleared as necessary before cuts are started. The escape path should extend back and diagonally to the rear of the expected line of fall as illustrated (Fig. 16).

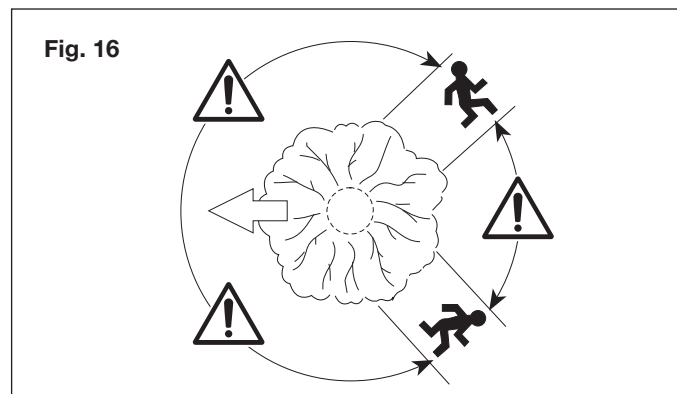

- iv) Before felling is started, consider the natural lean of the tree, the location of larger branches and the wind direction to help you judge which way the tree will fall.

**⚠️ WARNING!** Do not fell trees in the period of high wind or heavy precipitation. Wait to do your cutting until the hazard has ended.

**⚠️ WARNING!** Do not cut down trees that have an extreme lean or large trees that have rotten limbs, loose bark or hollow trunks. Have these trees pushed or dragged down with heavy equipment, and then cut up.

- v) Remove dirt, stones, loose bark, nails, staples and wire from the tree.

### • Notching undercut

Make the notch 1/3 the diameter of the tree, perpendicular to the direction of the fall as illustrated (Fig. 17).

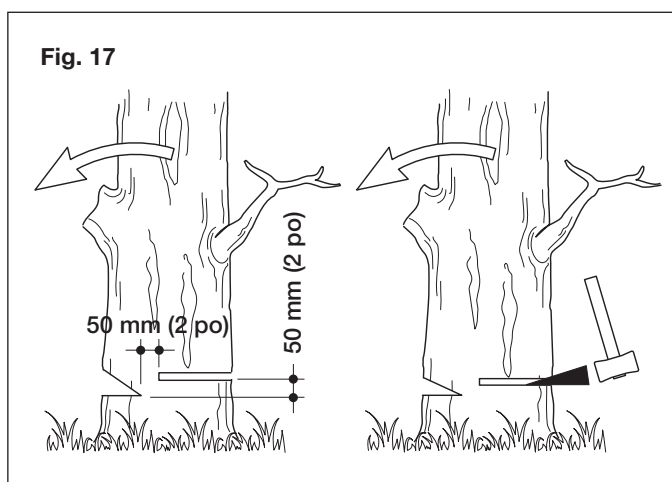

Make the lower horizontal notching cut first.

This will help to avoid pinching either the saw chain or the guide bar when the second notch is made.

### • Felling back cut

- i) Make the felling back cut at least 2 in. (50 mm) higher than the horizontal notching cut as illustrated (Fig. 16). Keep the felling back cut parallel to the horizontal notching cut. Strategically position the felling back cut so that enough wood is left to act as a hinge. The hinge wood keeps the tree from twisting and falling in the wrong direction. Do not cut through the hinge.
- ii) As the felling gets close to the hinge, the tree should begin to fall. If there is any chance that the tree may not fall in the desired direction or it may rock back and bind the saw chain, stop cutting before the felling back cut is complete and use wedges of wood, plastic or aluminium to open the cut and drop the tree along the desired line of fall.
- iii) When the tree begins to fall, remove the chain saw from the cut, stop the motor, put the chain saw down, then use the retreat path planned. Be alert for overhead limbs falling and watch your footing.

- **Limbing a tree**

Limbing is the process in which branches are removed from a fallen tree. When limbing, leave larger lower limbs to support the log off the ground. Remove the small limbs in one cut as illustrated (Fig. 18). Branches under tension should be cut from the bottom up to avoid binding the chain saw.

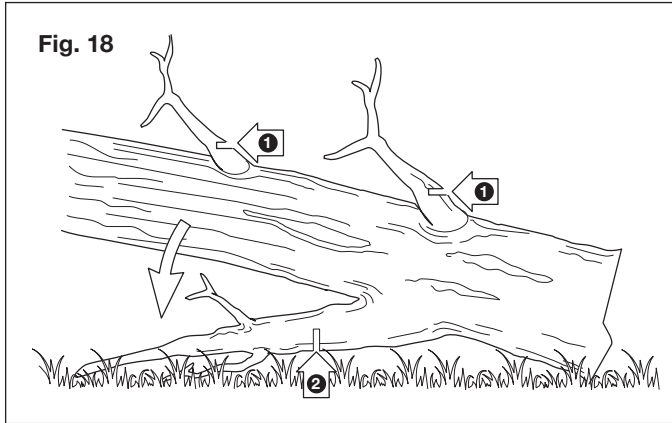

**⚠️ WARNING!** Pay special attention to where the branches are lying on the ground and recognize the following risks: 1) the branches may be under tension; 2) the direction in which the branch will fall during cutting may differ from what you had anticipated; 3) the tree may be unstable after the branch has been cut.

- **Bucking a log**

Bucking is the process in which a log is cut into lengths. It is important to make sure your footing is firm and your weight is evenly distributed on both feet. When possible, the log should be raised and supported by the use of limbs, logs or chocks. Follow these simple directions for easy cutting:

- i) When the log is supported along its entire length as illustrated (Fig. 19A), it is cut from the top (overbuck).

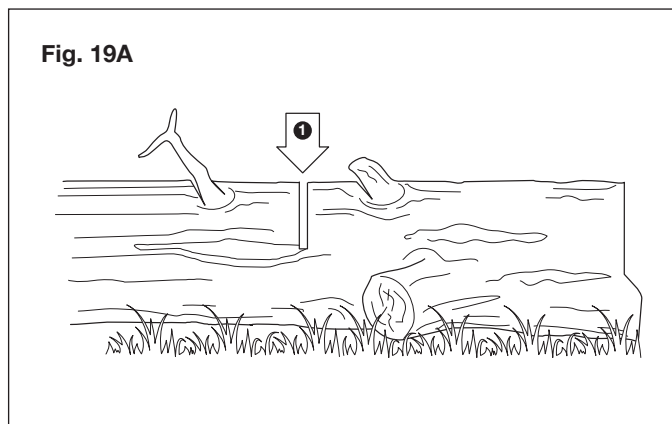

- ii) When the log is supported on one end (Fig. 19B), cut 1/3 the diameter from the underside (underbuck). Then make the finishing cut by overbucking to meet the first cut.

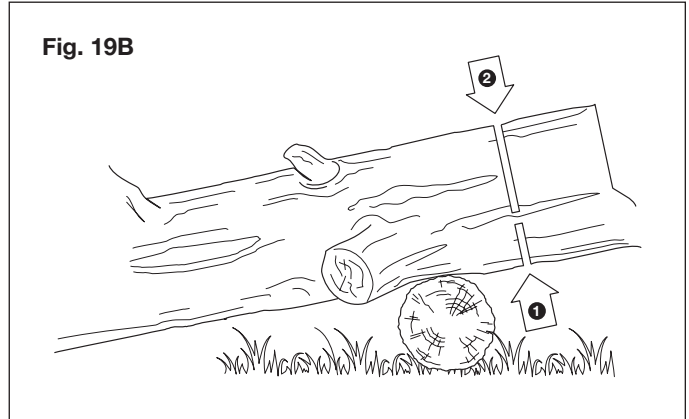

- iii) When the log is supported on both ends (Fig. 19C), cut 1/3 the diameter from the top (overbuck). Then make the finished cut by underbucking the lower 2/3 to meet the first cut.

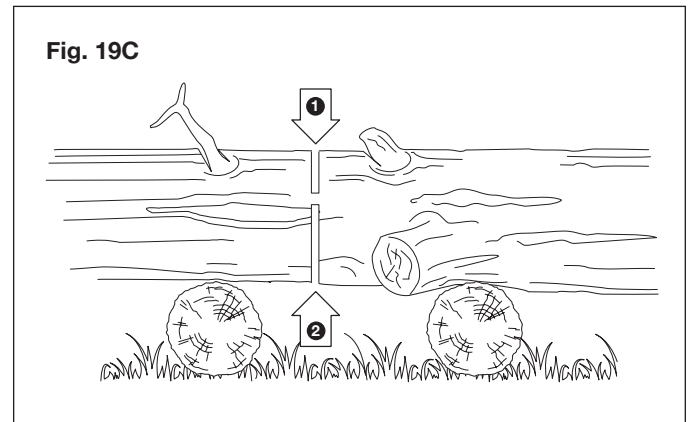

iv) It is easier to saw a log using the spiked bumper (Fig. 19D).

- Dig the spiked bumper into the log and use it as a pivot. Cut with an arched motion to make the bar penetrate the wood.
- Repeat several times if necessary, changing the point where you plant the spiked bumper.
- When bucking on a slope, always stand on the uphill side of the log (Fig. 20). When cutting through the log, maintain control by releasing the cutting pressure near the end of the cut without relaxing your grip on the chain saw handles. Do not let the chain contact the ground.

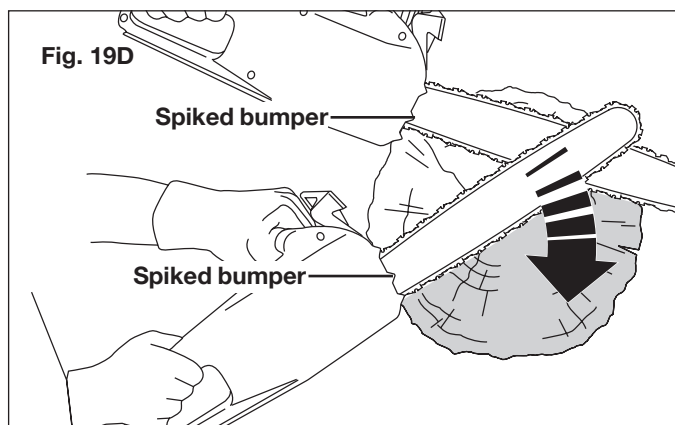

After completing the cut, wait for the saw chain to stop before you move the chain saw. Always stop the motor before moving from tree to tree.



## End of Operations

When you have finished your work:

- Switch off the motor and unplug the unit from the power source.
- Wait for the chain to stop and allow the machine to cool.
- Remove any traces of sawdust or oil deposits from the chain.

- If there is excessive dirt or resin build-up, disassemble the chain and place it in a container with a suitable cleanser. Then rinse it with clean water and treat it with a suitable anticorrosive spray before reassembling it on the machine.
- Fit the cutting bar sheath onto the bar before storing.

**⚠ WARNING!** Let the motor cool completely before storing the chain saw in any enclosure.

To reduce fire hazards, clean the machine thoroughly to remove sawdust, branches, leaves or excess grease. Never leave containers with cut debris inside the storage area.

## Maintenance

Please contact an authorized Snow Joe® + Sun Joe® dealer or call the Snow Joe® + Sun Joe® customer service center at 1-866-SNOWJOE (1-866-766-9563) for all maintenance operations not foreseen in this manual. Any operation performed in an unauthorized service center or by unqualified personnel will completely invalidate the warranty.

**⚠ WARNING!** For your safety and that of others:

- Correct maintenance is essential to maintain the original efficiency and safety of the machine over time.
- Keep all nuts, bolts, and screws tight to be sure the equipment is in safe working condition.
- Never use the machine with worn or damaged parts. Damaged parts are to be replaced and never repaired.
- Only use original Snow Joe® + Sun Joe® replacement parts. Parts that are not of the same quality can seriously damage the equipment, compromise safety, and invalidate the warranty.

**⚠ WARNING!** Always unplug the unit from the power source before performing any adjustments, maintenance, or repairs to your electric chain saw.

- Use protective gloves when handling the bar and chain.
- Keep the protective cutting bar sheath on, except when intervening directly on the bar or the chain.
- Never dispose of oils or other pollutive materials in unauthorized places.

## Motor Cooling

To avoid overheating and damage to the motor, always keep the cooling air vents clean and free of sawdust and debris.



## Chain Tension

Check the chain tension before using the saw when the chain is cold. The correct tension of a cold chain is when there is no slack on the underside of the guide bar; the chain is snug, but you can rotate it by hand without binding.

During normal saw operation, the temperature of the chain will increase. The drive links of a correctly tensioned warm chain will hang approximately 0.050 in. (1.25 mm) out of the bar groove (Fig. 21). Be aware that a chain tensioned while warm, may be too tight upon cooling. Check the “cold tension” before next use. The chain must be re-tensioned whenever the flats on the drive links hang out of the bar groove (Fig. 21).

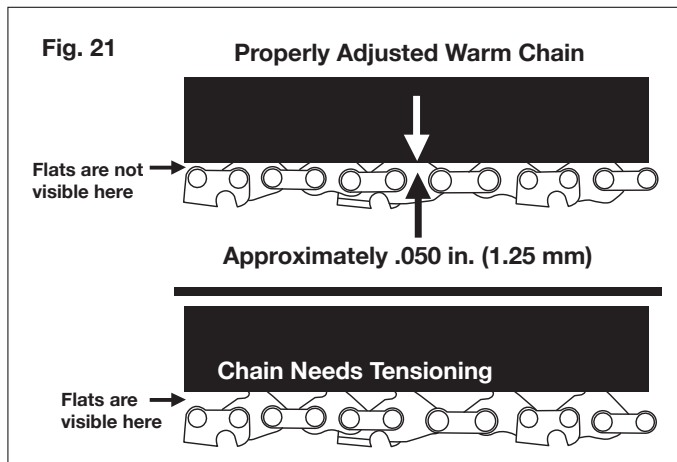

**NOTE:** A new chain tends to stretch. Check the chain tension frequently and re-tension as needed.

## Nuts and Screws

Periodically check that all the nuts and screws are securely tightened and the hand grips are tightly fastened.

## Chain Sharpening

**⚠ WARNING!** To ensure that the chain saw works safely and efficiently, it is essential that the cutting components are well-sharpened. **It is highly recommended to replace the chain once it loses its ability to cut cleanly and safely.** It is possible, however, to sharpen the existing chain if the sharpening is carefully performed. Any work on the chain and bar requires specific experience and special tools. For safety purposes, we recommend you contact an authorized Snow Joe® + Sun Joe® dealer or call the Snow Joe® + Sun Joe® customer service center at 1-866-SNOWJOE (1-866-766-9563).

Sharpening is necessary when:

- The sawdust looks like dust.
- Cutting becomes more difficult.
- The cut is not straight.
- Vibrations increase.

An authorized service center will sharpen the chain using the right tools to ensure minimum removal of material and even sharpness on all the cutting edges.

If you sharpen the chain yourself, use special round-section files with the right diameter depending on the type of chain (see “Chain Maintenance Table” pg. 18). You need a certain amount of skill and experience to avoid damaging the cutting edges.

Sharpen the chain as follows (Fig. 22):

- Secure the bar firmly, with the chain mounted, in a suitable vice.
- Tighten the chain if it is loose.
- Mount the file in the guide and then insert it in the tooth at a constant angle from the cutting edge.
- Sharpen in a forward motion a few times and repeat this on all the cutting edges facing the same way (right or left).
- To move the chain forward, use a screwdriver.
- Turn the bar over in the vice and repeat on all the other cutting edges.
- Check that the depth limiter tooth does not stick out farther than the inspection tool and file any projecting parts with a flat file, rounding off the edges (Fig. 22).
- After sharpening, remove all traces of filing and dust and lubricate the chain in an oil bath. Replace the chain whenever:
  - The length of the cutting edges decreases to 5 mm or less;
  - There is too much play between the links and the rivets.

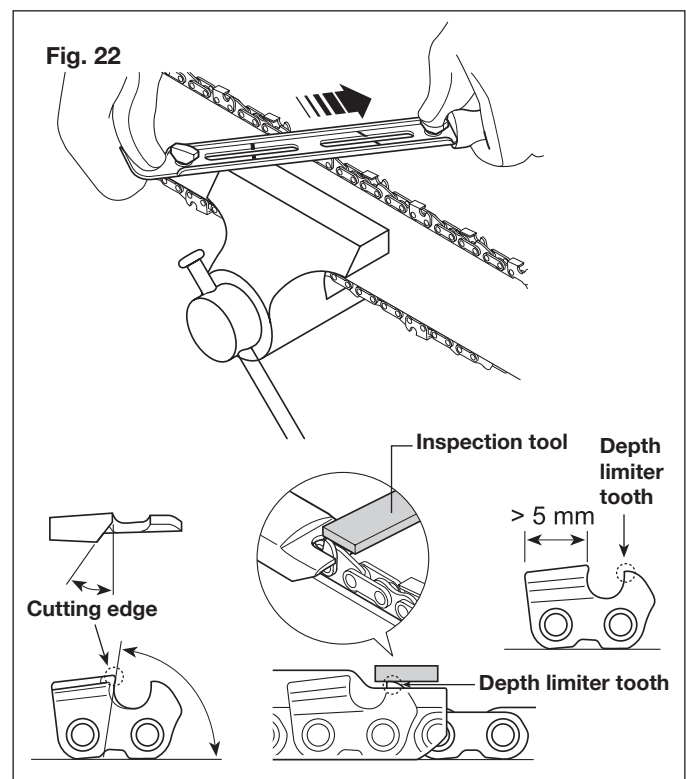

## Guide Bar Maintenance

When the guide bar shows signs of wear, turn it over on the saw to distribute the wear for maximum bar life. Feathering or burring of the bar rails is a normal process of bar wear. You should smooth such faults with a file as soon as they occur.

Replace a bar with any of the following faults:

- Wear inside the bar rails permitting the chain to lay over sideways
- Bent guide bar
- Cracked or broken rails
- Spread rails

Turn the saw over, check the underside of the guide bar, and make sure that the lubrication holes and chain groove are free from impurities.

You can purchase replacement parts for your Sun Joe® SWJ701E electric chain saw by ordering online at snowjoe.com or, to order by phone, contact Snow Joe® + Sun Joe® customer service at 1-866-SNOWJOE (1-866-766-9563).

## Chain Sprocket

Regularly check the condition of the sprocket and replace it when wear exceeds 0.5 mm (Fig. 23).

Do not mount a new chain with a worn sprocket or vice-versa.

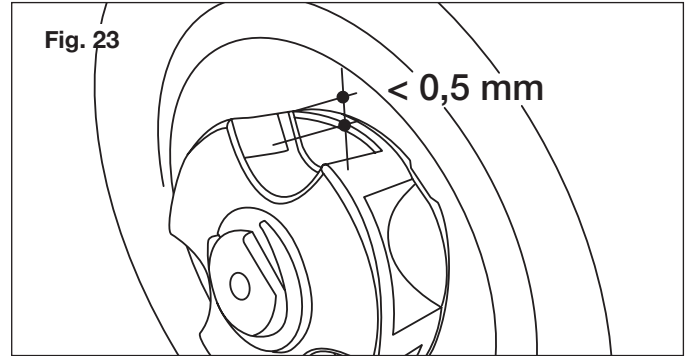

## Storage

After every work session, clean the machine thoroughly to remove all dust and debris and slide the bar sheath over the cutting bar. Repair or replace any faulty parts on the unit.

Store the machine in a dry, locked place out of the reach of children.

## Support

If your Sun Joe® SWJ701E electric chain saw requires service or maintenance, please call 1-866-SNOWJOE (1-866-766-9563) for assistance.

## Model and Serial Numbers

When contacting the company, reordering parts or arranging service from an authorized dealer, you will need to provide the model and serial numbers, which can be found on the decal located on the housing of the unit. Copy these numbers into the space provided below.

Record the following numbers from the housing or handle of your new product:	
Model #:	_____
Serial #:	_____

## Chain Maintenance Table

Drive Links	Chain Pitch		Chain Gauge		File Diameter	
	inches	mm	inches	mm	inches	mm
62	3/8	9.5	0.050	1.3	5/32	4

# Troubleshooting

Fault	Possible Cause	Remedy
The motor does not start when you switch it on	<ul style="list-style-type: none"> <li>• Cord not connected to the power source</li> </ul>	<ul style="list-style-type: none"> <li>• Make sure that the cord is connected to a power source</li> </ul>
	<ul style="list-style-type: none"> <li>• Trigger switch not operational</li> </ul>	<ul style="list-style-type: none"> <li>• Check safety lock button is fully depressed prior to engaging the trigger switch</li> </ul>
	<ul style="list-style-type: none"> <li>• Extension cord not connected to the plug</li> </ul>	<ul style="list-style-type: none"> <li>• Check extension cord is fully connected to the tool</li> </ul>
	<ul style="list-style-type: none"> <li>• Extension cord or power cable damaged</li> </ul>	<ul style="list-style-type: none"> <li>• Repair or replace the damaged cord</li> </ul>
	<ul style="list-style-type: none"> <li>• Worn motor brushes</li> </ul>	<ul style="list-style-type: none"> <li>• Motor brushes must be replaced</li> </ul>
Bar and chain running hot and smoking	<ul style="list-style-type: none"> <li>• Chain tension too tight</li> </ul>	<ul style="list-style-type: none"> <li>• Adjust chain tension</li> </ul>
	<ul style="list-style-type: none"> <li>• Oil tank empty</li> </ul>	<ul style="list-style-type: none"> <li>• Fill tank with chain oil</li> </ul>
	<ul style="list-style-type: none"> <li>• Chain installed backwards</li> </ul>	<ul style="list-style-type: none"> <li>• Reverse chain so that cutters face the right direction</li> </ul>
Motor runs but chain is not rotating	<ul style="list-style-type: none"> <li>• Chain tension too tight</li> </ul>	<ul style="list-style-type: none"> <li>• Adjust chain tension</li> </ul>
	<ul style="list-style-type: none"> <li>• Guide bar and chain may be damaged</li> </ul>	<ul style="list-style-type: none"> <li>• Replace the chain and bar with the identical replacement part</li> </ul>
Poor cutting performance	<ul style="list-style-type: none"> <li>• Blunt saw chain</li> </ul>	<ul style="list-style-type: none"> <li>• Sharpen or replace the saw chain</li> </ul>
	<ul style="list-style-type: none"> <li>• Incorrect chain tension</li> </ul>	<ul style="list-style-type: none"> <li>• Check chain tension</li> </ul>
	<ul style="list-style-type: none"> <li>• Saw chain fitted incorrectly</li> </ul>	<ul style="list-style-type: none"> <li>• Check saw chain orientation</li> </ul>
Chain jumps off guide bar	<ul style="list-style-type: none"> <li>• Incorrect chain tension</li> </ul>	<ul style="list-style-type: none"> <li>• Check chain tension</li> </ul>
Chain works with difficulty	<ul style="list-style-type: none"> <li>• Incorrect chain tension</li> </ul>	<ul style="list-style-type: none"> <li>• Check chain tension</li> </ul>

# Optional Accessories

**⚠️ WARNING!** ALWAYS use only authorized Snow Joe® + Sun Joe® replacement parts and accessories. NEVER use replacement parts or accessories that are not intended for use with this saw. Contact Snow Joe® + Sun Joe® if you are unsure whether it is safe to use a particular replacement part or accessory with your saw. The use of any other attachment or accessory can be dangerous and could cause injury or mechanical damage.

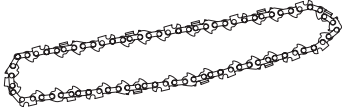
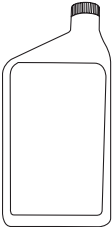
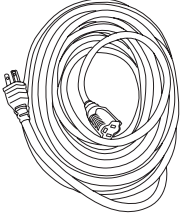
Accessories	Item	Model
<p>①</p> 	18-Inch Guide Bar	SWJ-18BAR
<p>②</p> 	18-Inch Cutting Chain	SWJ-18CHAIN
<p>③</p> 	Bar and chain oil	SWJ-OIL (sold at snowjoe.com or you can purchase equivalent bar and chain oil sold at your local hardware store)
<p>④</p> 	Snow Joe® + Sun Joe® SJTW-A 14-gauge 50-foot extension cord with lighted end	PJEXT50-B

**NOTE:** Accessories are subject to change without any obligation on the part of Snow Joe® + Sun Joe® to provide notice of such changes. Accessories can be ordered online at snowjoe.com or via phone by contacting the Snow Joe® + Sun Joe® customer service center at 1-866-SNOWJOE (1-866-766-9563).







## SNOW JOE® + SUN JOE® CUSTOMER PROMISE

**ABOVE ALL ELSE**, Snow Joe® + Sun Joe® are dedicated to you, our customer. We strive to make your experience as pleasant as possible. Unfortunately, there are times when a product does not work or breaks under normal operating conditions. We think it's important that you know what you can expect from us. That's why we created the Snow Joe® + Sun Joe® promise.

**OUR PROMISE:** Snow Joe® + Sun Joe® warrant new products for two years from the date of purchase. If your product does not work, or there's an issue with a specific part, we will fix this by either sending you a free replacement part or by sending you a new or comparable product at no charge. How cool is that! Before you know it, you'll be back in action cutting, sawing, mowing, washing and...?

### PRODUCT REGISTRATION:

Snow Joe®, LLC ("Snow Joe® + Sun Joe®") strongly encourages you to register your purchase. You can register online at [snowjoe.com/ProductRegistration](http://snowjoe.com/ProductRegistration), or by printing and mailing in a registration card available online from our website, or calling our Customer Service Department at **1-866-SNOWJOE (1-866-766-9563)**, or by e-mailing us at [help@snowjoe.com](mailto:help@snowjoe.com). Failure to register your product purchase will not diminish your warranty rights. However, registering your purchase will allow Snow Joe® + Sun Joe® to better serve you with any of your customer service needs.

### WHO CAN SEEK WARRANTY COVERAGE?

This Warranty is extended by Snow Joe® + Sun Joe® to the owner of this Machine (a "Machine" consists of a product powered by a motor) for residential and personal household use only. This Warranty does not apply to products used for commercial, rental or re-sale purposes. Should ownership of this machine change during the 2-year period, please update the Machine's owner information at [snowjoe.com/ProductRegistration](http://snowjoe.com/ProductRegistration).

### WHAT IS COVERED?

Snow Joe® + Sun Joe® warrants to the owner that if this Machine fails within 2 years from the date of purchase due to a defect in material or workmanship or as a result of normal wear and tear from ordinary household use, Snow Joe® + Sun Joe® will send a replacement part or product, as needed, free of charge and with free shipping to the original purchaser.

If, in Snow Joe® + Sun Joe®'s sole discretion, the failed Machine cannot be repaired with a part, Snow Joe® + Sun Joe® will elect to either (A) send a new Machine at no charge and with free shipping or (B) refund the full purchase price to the owner.

### WHAT IS NOT COVERED?

This Warranty does not apply to the Machines that have been used commercially or in non-household applications. This Warranty does not cover cosmetic changes that do not affect performance. This Warranty is only valid if the Machine is used and maintained in accordance with the instructions, warnings and safeguards contained in the owner's manual. Snow Joe® + Sun Joe® will not be responsible for the cost of any unauthorized warranty repairs. This warranty does not cover any cost or expense incurred by the purchaser in providing substitute equipment or service during reasonable periods of malfunction or non-use of this product while waiting for a replacement part or unit under this warranty.

Wearing parts like belts, augers, chains and tines are not covered under this warranty, and can be purchased at [snowjoe.com](http://snowjoe.com) or by calling **1-866-SNOWJOE (1-866-766-9563)**. Batteries are covered in full for 90-days from the date of purchase.

Repair, replacement or refund of the purchase price are the exclusive remedies of purchaser and the sole liability of Snow Joe® + Sun Joe® under this warranty. No employee or representative of Snow Joe® + Sun Joe® is authorized to make any additional warranty or any modification to this warranty which may be binding upon Snow Joe® + Sun Joe®. Accordingly, purchaser should not rely upon any additional statements made by any employee or representative of Snow Joe® + Sun Joe®. In no event, whether based on contract, indemnity, warranty, tort (including negligence), strict liability or otherwise, shall Snow Joe® + Sun Joe® be liable for any special, indirect, incidental, or consequential damages, including, without limitation, loss of profit or revenue.

Some states do not allow limits on warranties. In such states, the above limitations may not apply to you.

Outside the USA, other warranties may apply.



**snowjoe.com**

**⚠WARNING!** This product or its power cord contains chemicals, including lead, known to the State of California to cause cancer and birth defects or other reproductive harm. Wash hands after handling. For more information go to [www.P65Warnings.ca.gov](http://www.P65Warnings.ca.gov).

**⚠WARNING!** Some dust created by power sanding, sawing, grinding, drilling, and other construction activities contains chemicals known [to the State of California] to cause cancer, birth defects, or other reproductive harm. Some examples of these chemicals are:

- lead from lead-based paints,
- crystalline silica from bricks and cement and other masonry products, and
- arsenic and chromium from chemically-treated lumber.

Your risk from these exposures varies, depending on how often you do this type of work. To reduce your exposure to these chemicals: work in a well ventilated area, and work with approved safety equipment, such as those dust masks that are specifically designed to filter out microscopic particles. For more information go to [www.P65Warnings.ca.gov](http://www.P65Warnings.ca.gov).